

# **Ice Pigging: A NEW APPROACH TO CLEANING PRESSURISED PIPELINES**

**Graeme Berriman – Operations Manager  
Suez Water**

September 2018



# ► Agenda

- Introduction
- What is ice pigging
- How we deliver our service
- Blackwater Water, Central Highlands Regional Council
- Macksville, Nambucca Shire Council
- Summary of benefits

# ICE PIGGING

the *best and most cost effective method* for removing **sediment, biofilm and loose material** from pressurised pipes



# How we deliver the service

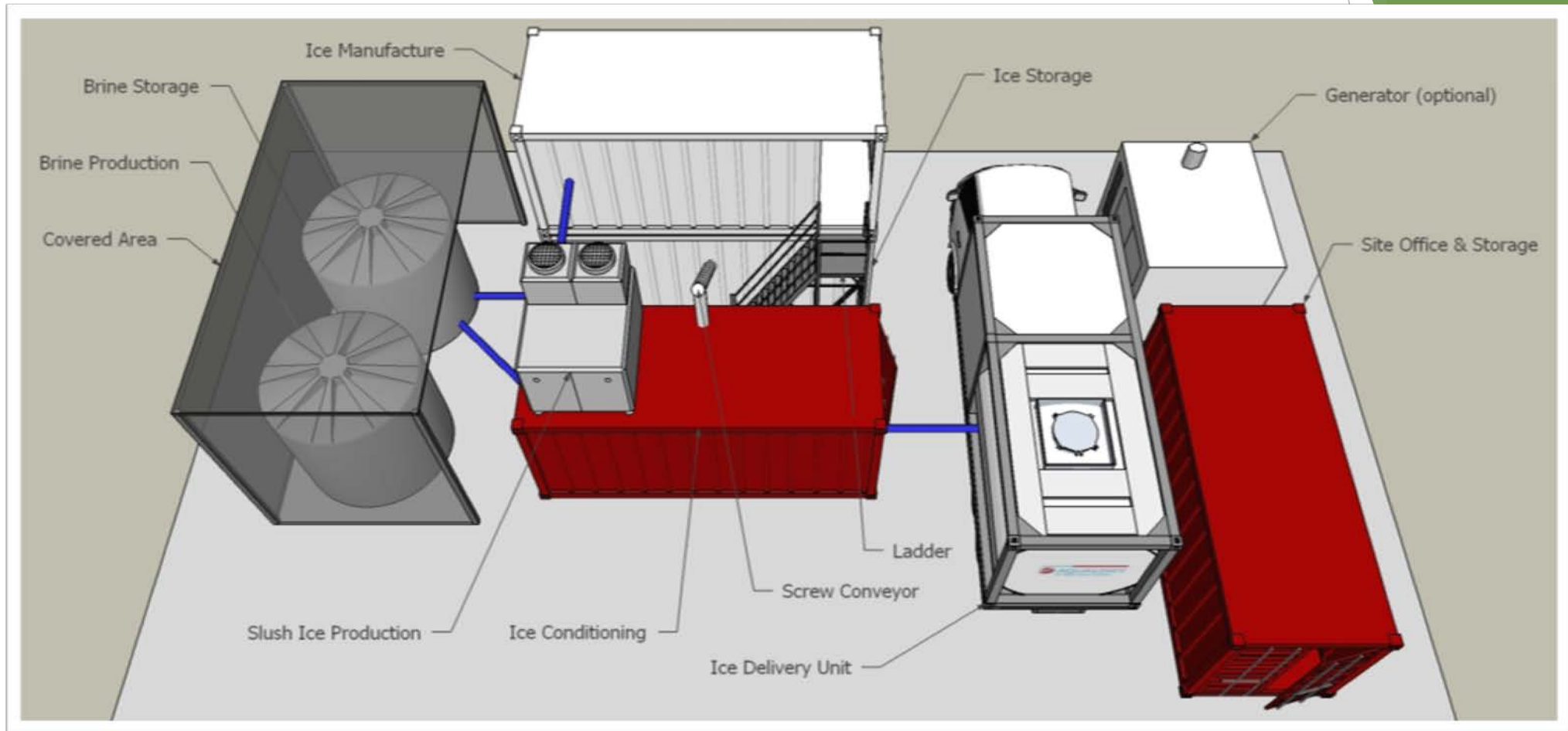

Portable ice making facility

# How we deliver the service



Ice Delivery Truck

# How we deliver the service

- ▶ Flow
- ▶ Pressure
- ▶ Conductivity
- ▶ Temperature
- ▶ Turbidity



# How does it work?

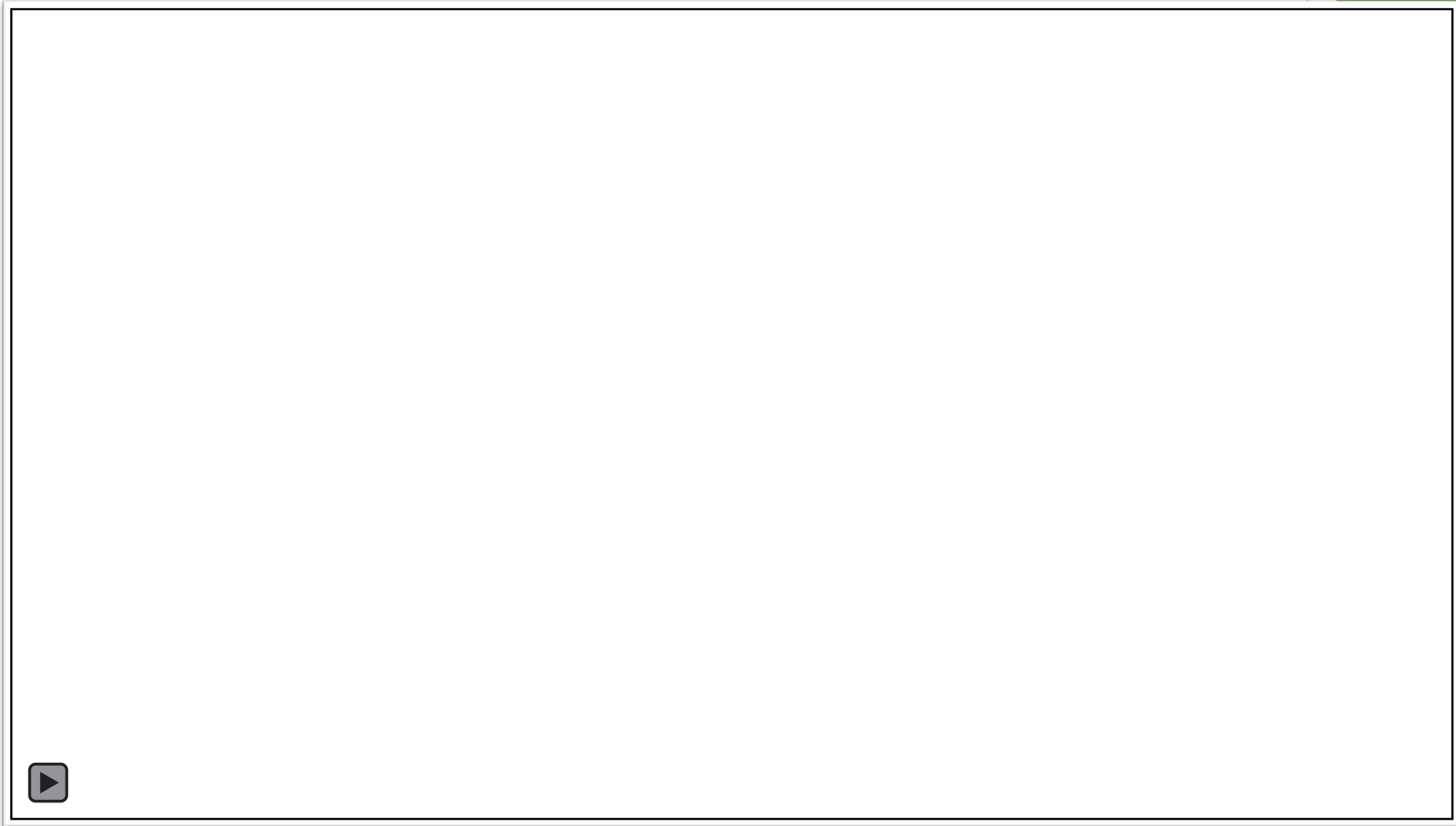

# How does it work?

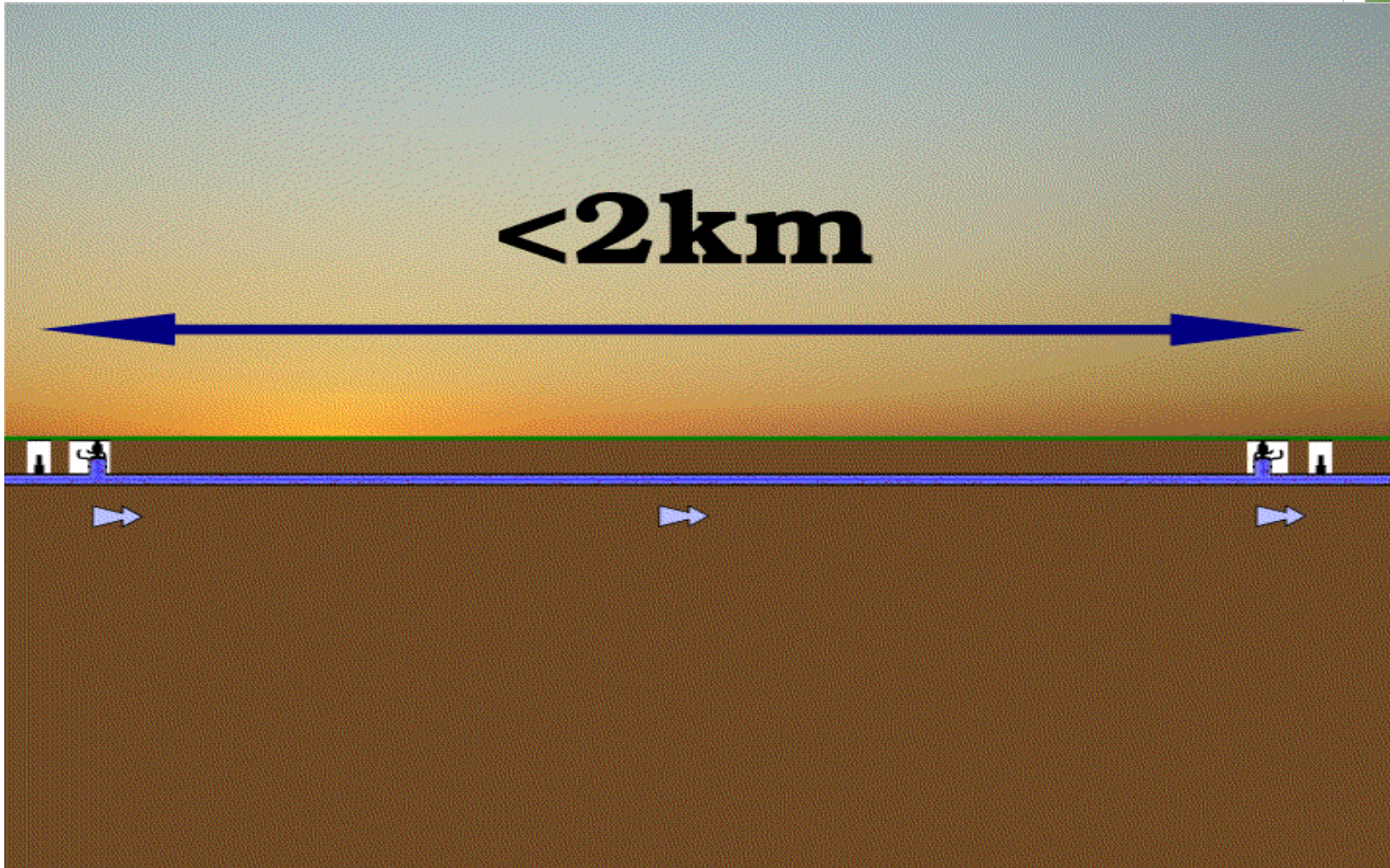



## ► Does it work?



ICE PIGGED AND SWABBED A WEEK LATER

# How we deliver the service

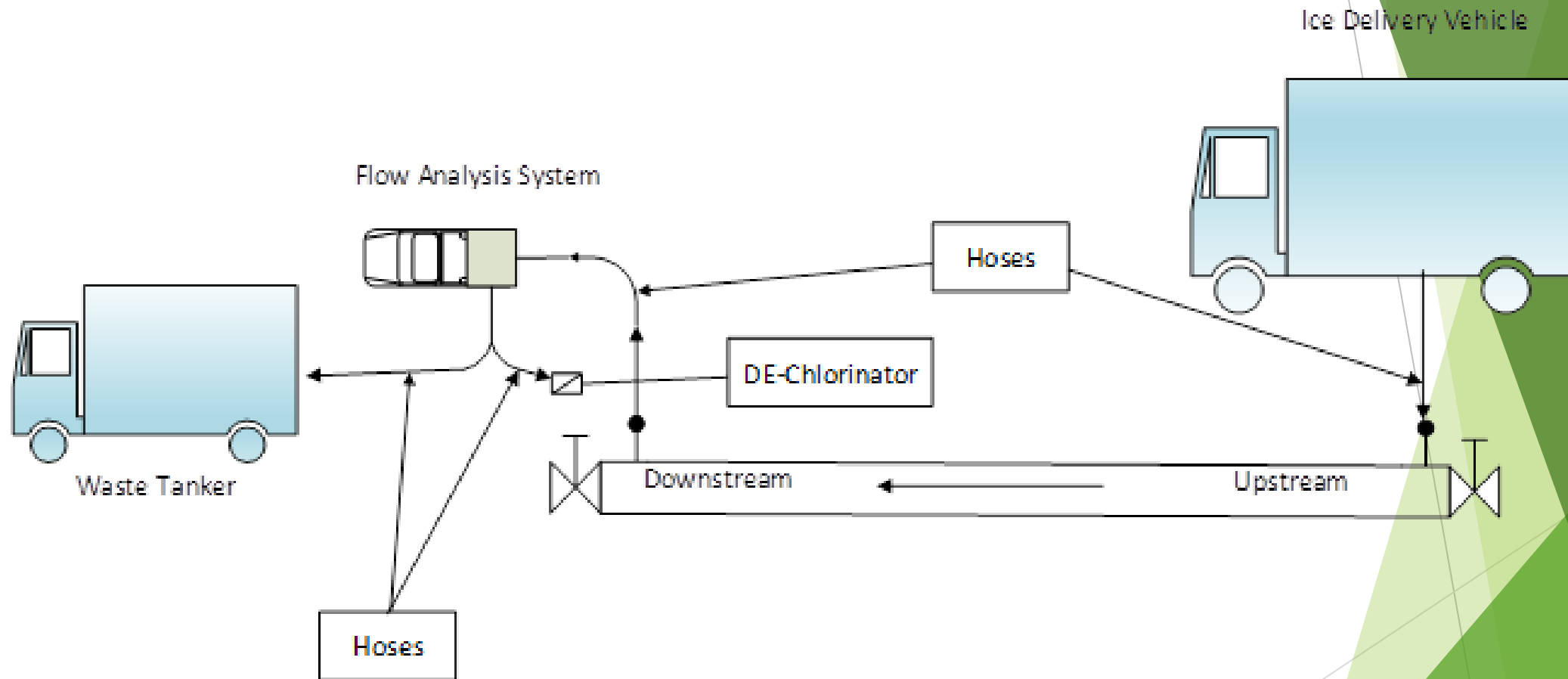

# Central Highlands Regional Council

Blackwater QLD – 72.9KM in 2015



# Central Highlands Regional Council

## Blackwater QLD



f Blackwater Water

Blackwater Water

Public Group

- About
- Discussion
- Members
- Events
- Videos
- Photos
- Files

Search this group

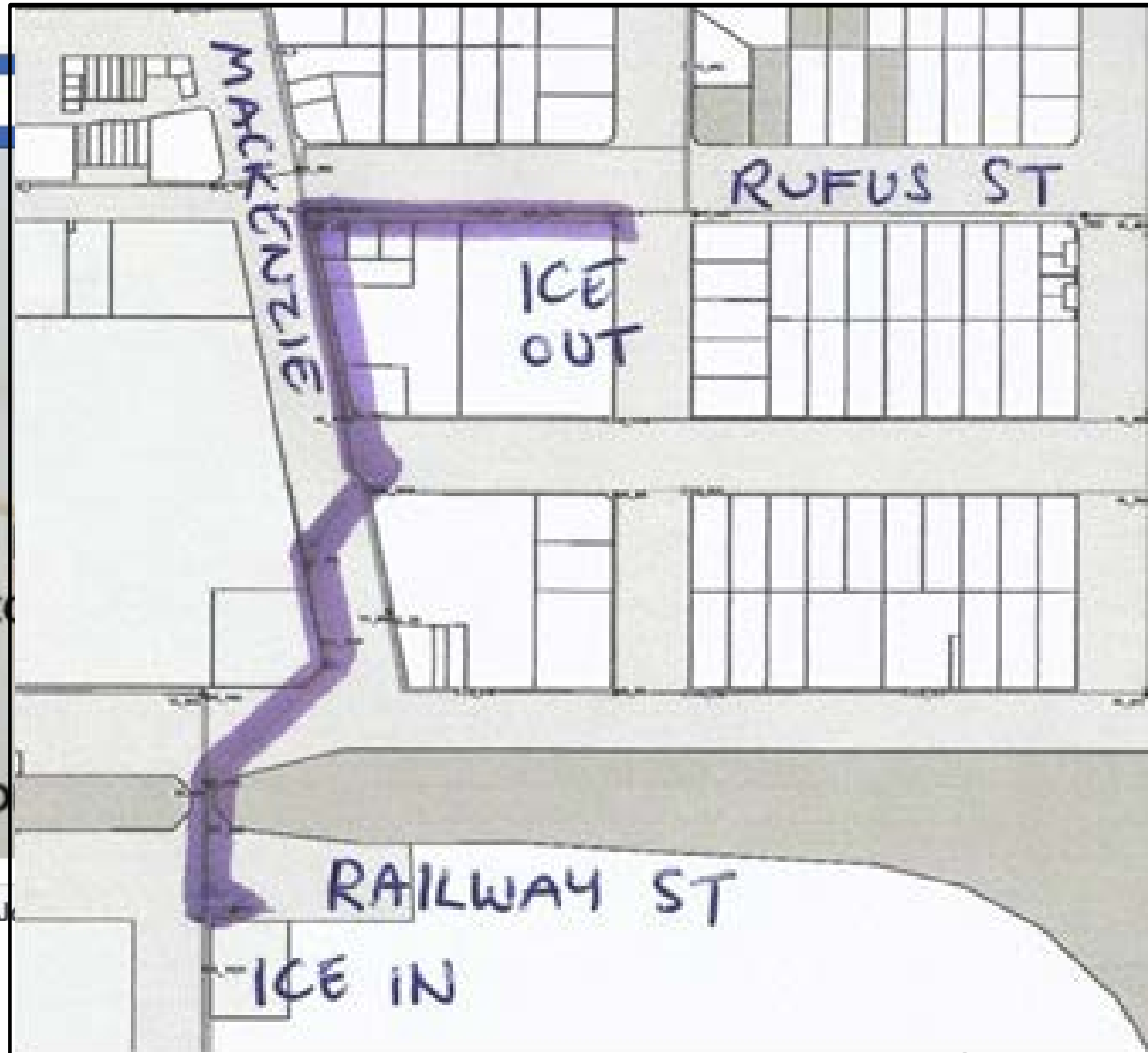

Friends

2 686

d.gov.au

s. These are regularly  
with the CHRC however  
d to CHRC directly.

report ANY discolouration

# ► Central Highlands Regional Council



## Blackwater QLD

<i>Sample #</i>	<i>Time (s)</i>	<i>Flow Rate (l/s)</i>	<i>Temp (<u>°</u> C)</i>	<i>Sample Mass (g)</i>	<i>Sediment Mass (g)</i>	<i>Sediment Conc. (g/l)</i>
1	14:23:00	13.2	19.6	323	0.3	0.93
2	14:24:00	13.1	17.4	326	0.3	0.92
3	14:25:00	13.1	13.4	337	0.3	0.89
4	14:26:00	13.3	8.8	350	0.4	1.14
5	14:27:00	13.2	5.6	320	0.5	1.56
6	14:28:00	13.3	3.5	339	0.9	2.65
7	14:29:00	13.3	2.2	308	2.7	8.77
8	14:30:00	13.4	-2	342	1.7	4.97
9	14:31:00	13.4	-2.8	376	2.4	6.38
10	14:32:00	13.4	-3.5	332	1.3	3.92
11	14:33:00	13.5	-3.4	326	1.2	3.68
12	14:34:00	13.5	-3.4	326	1	3.07
13	14:35:00	13.3	-3.3	326	0.7	2.15
14	14:36:00	13.5	-2.4	326	0.2	0.61
15	14:37:00	13.5	4.4	337	0.01	0.03
<b>Sediment Removed (kg):</b>			<b>33.39</b>	<b>Sediment Removed per km (kg):</b>		<b>66.78</b>

# Outcome



The screenshot shows a Facebook post within a group named 'Blackwater Water'. The post is from user Joan Christie, dated January 27, 2017. The post content is as follows:

LOST DOG:

8:14 pm

Search in Blackwater Bu...

**Cody Jasmin**  
20 mins

**Missing Dog...Hunter Street area**  
**FREE**

♦ Rockhampton, Queensland

Dog missing Hunter Street area. He is black with brown paws. Name is Bruiser. He is from Rocky but partner took him out for work so he doesn't know the area. Please if you see him contact me on 0447776653 or comment on here. Thank you

The post includes two photographs: one showing a person sitting on the floor with a black dog, and another showing a close-up of the dog's face.

Like Comment Share

Write a comment...

# Ice-pigging sewer rising mains

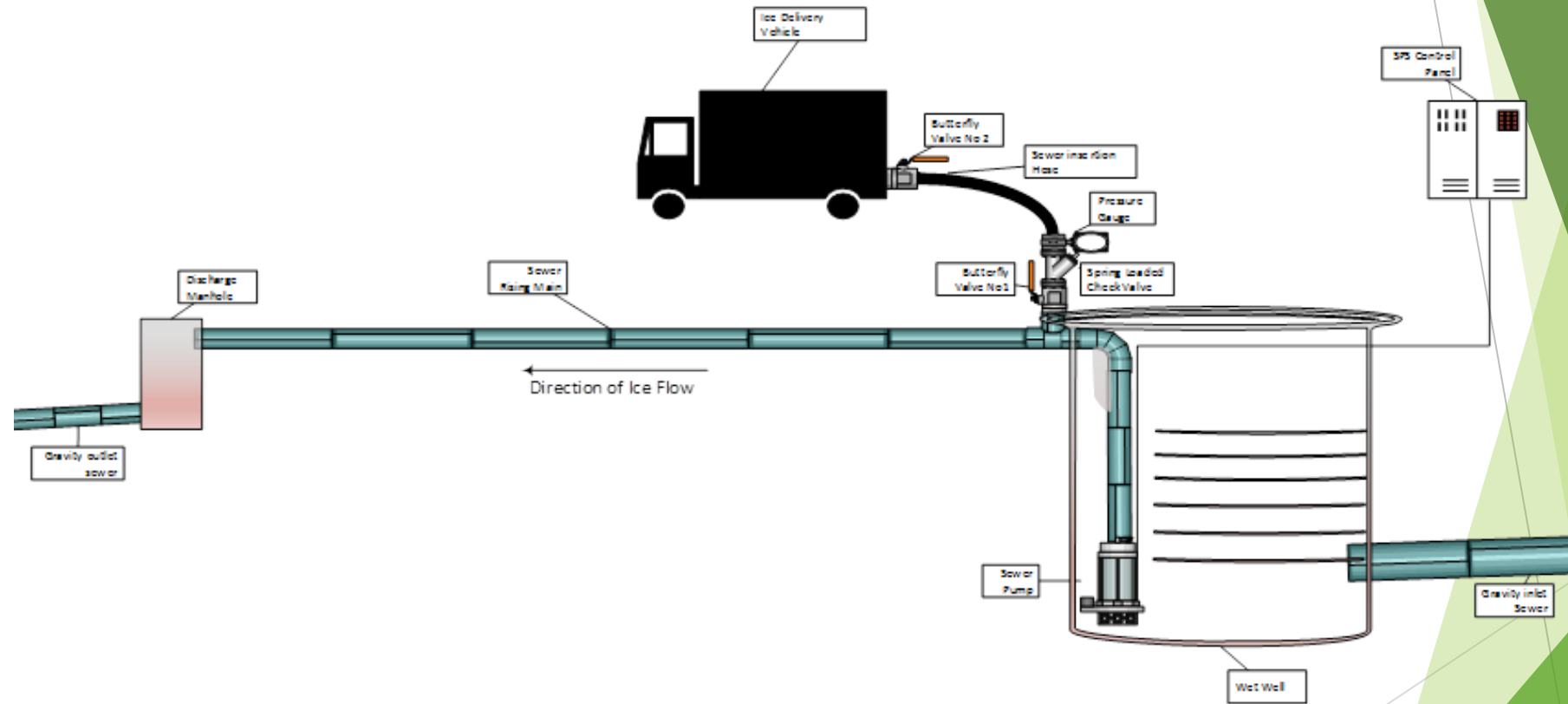

# Nambucca Shire Council



- ▶ 670M X 100mm diameter UPVC & Cast Iron pipe.



# Nambucca Shire Council

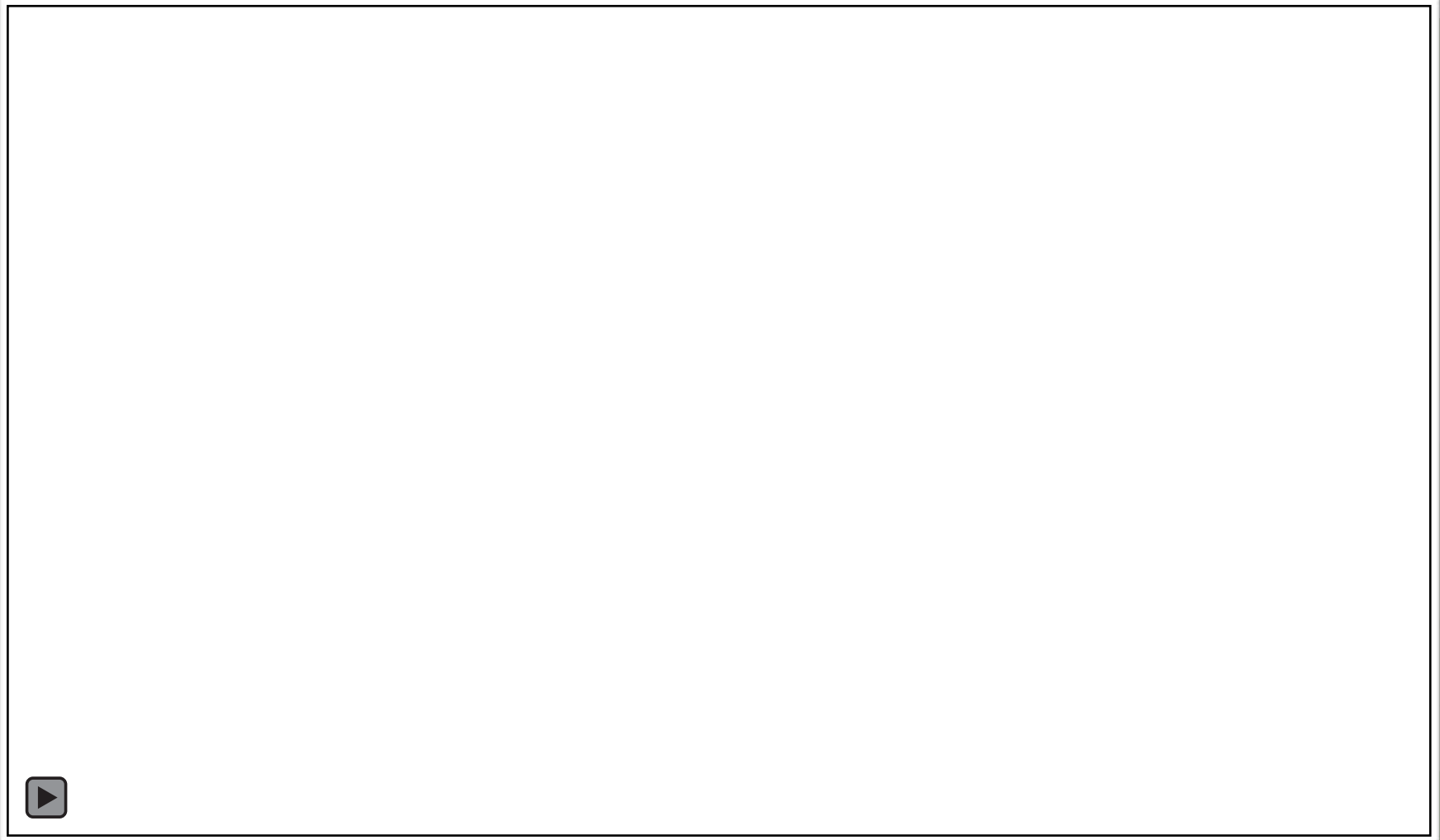

▶ Before - 3.5 l/s      After - 9 l/s



**Thank you for your attention !  
Questions?**

